

XTOOL

xTool M2 20W/40W Module



Statement - - - - - 01

List of items - - - - - 01

Meet xTool M2 20W/40W Module - - - - - 01

Install the laser module - - - - - 04
(take the 20W module as an example)

Use xTool M2 20W/40W Module - - - - - 06

Compliance statements - - - - - 07

After-sales services - - - - - 08

XTOOL

xTool M2 20W/40W Module



Statement

Thank you for choosing xTool products!

If you use the product for the first time, read carefully all the accompanying materials of the product to improve your experience with it. If you do not use the product according to the instructions and requirements of the Manual, or mis-operate the product due to misunderstanding, etc., the Company shall bear no responsibility for any loss resulting therefrom.

The Company has collated the content of the Manual rigorously and carefully, but errors or omissions may remain.

The Company is committed to continuously improving product functions and service quality, and therefore reserves the right to change any product or software described in the Manual and the content of the Manual at any time.

The Manual is intended to help you use the product properly and does not include any description of hardware and software configuration. For product configuration, refer to the related contract (if any) and packing list, or consult your distributor. Images in the Manual are for reference only and the actual product may vary.

Protected by copyright laws and regulations, the Manual shall not be reproduced or transcribed in any way, or be transmitted on any wired or wireless network in any manner, or be translated into any language, or be modified in any way, such as content, image, or layout modification, without the prior written authorization of the Company.

The Company is committed to continuously improving the product and related materials. The product and the Manual are subject to change, and updates can be found at xtool.com.

Please do not attempt repairs without contacting xTool Support.

List of items



xTool M2
20W/40W module



Power adapter

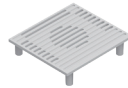

Exhaust fan
inner cover



User manual

Laser module power	Power adapter power
20 W	25V 6A
40 W	25V 8A

Meet xTool M2 20W/40W Module

Warning and instruction signs

20W module

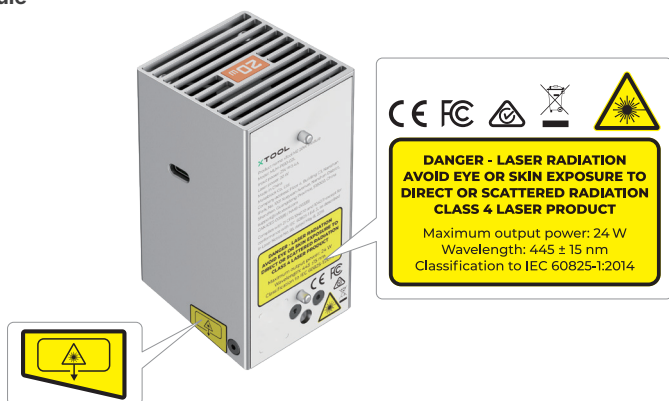

40W module

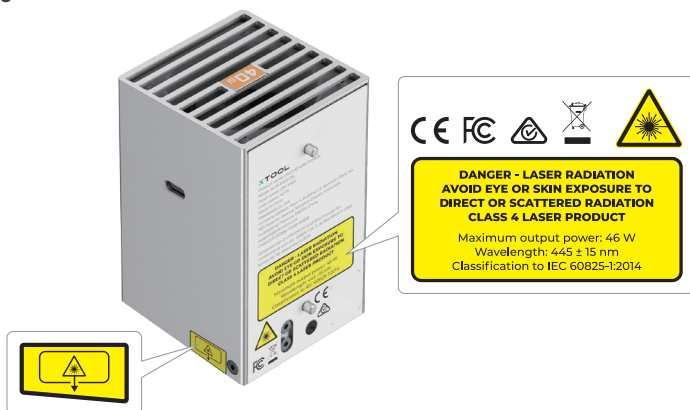

Laser specifications

	Wavelength	Beam divergence	Maximum power output
Working laser	445 ± 15 nm	1.5 mrad (IEC 60825-1 Default (simplified))	24 W
			46 W

Working temperature

The 20W/40W module works properly at the temperature of 0°C to 35°C.



If you use a 40W module, check the inner cover of the exhaust fan before processing. If it does not match the appearance shown below, replace it with the inner cover included in the package.

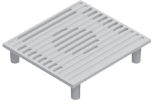

When installing the smoke exhaust pipe cover, hold the inner cover of the exhaust fan in place with one hand.

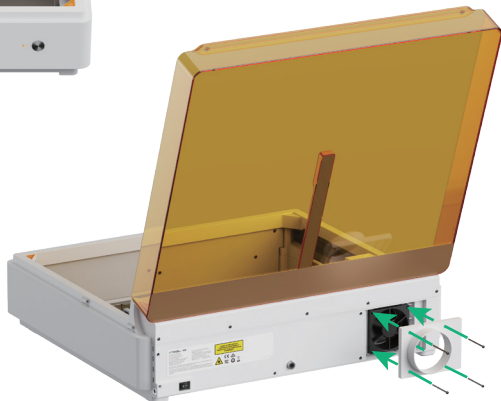
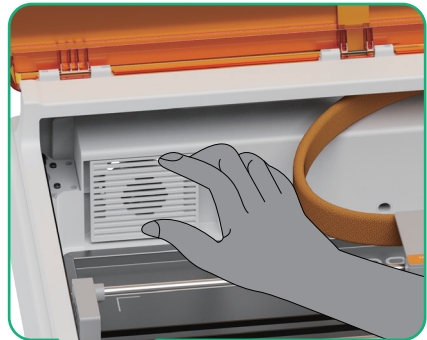

Install the laser module (take the 20W module as an example)



- Ensure that xTool M2 is powered off before installing.
- Use the infrared module only with xTool M2. Before use, read and follow **Safety Instructions** and **Quick Start Guide** of xTool M2.

1

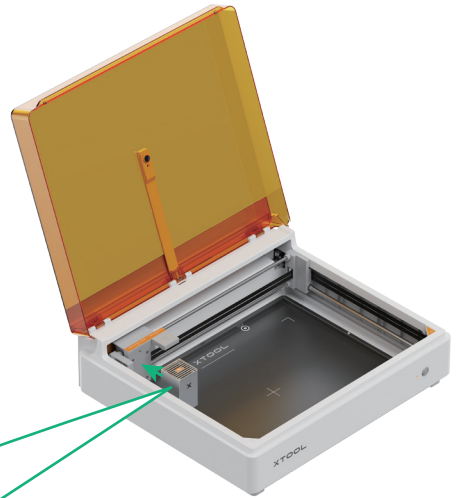
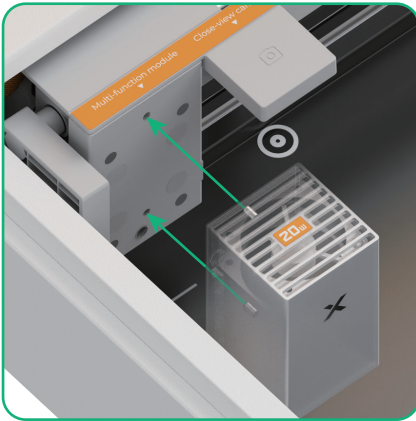

When you install the laser module, the two location pins on the back of the laser module and the multi-function module holder should be aligned.

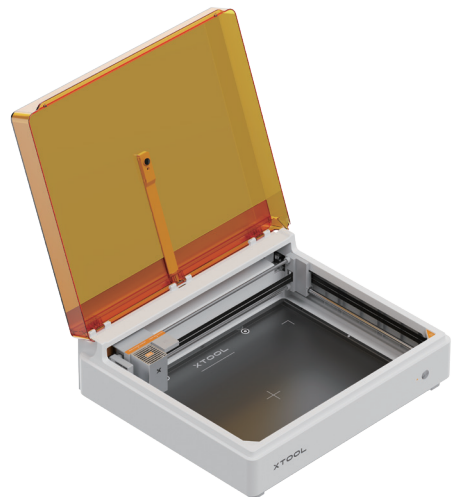

2



Module connection cable
(included in the package of xTool M2)

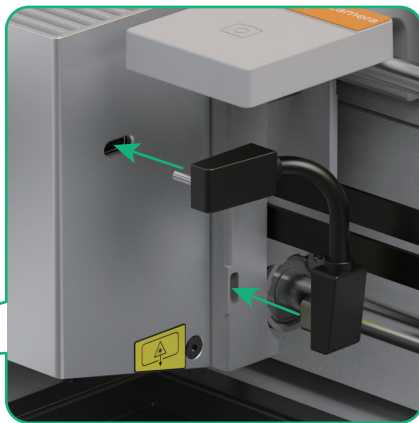
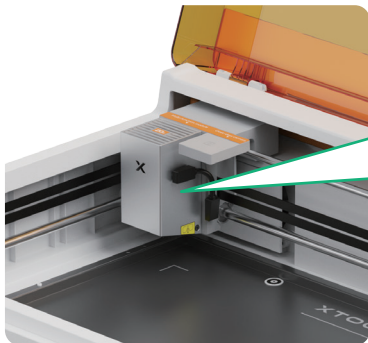

3 Connect to a power supply and turn on the power switch



Power cable (included in
the package of xTool M2)



Use a power adapter that matches
the power of the laser module.

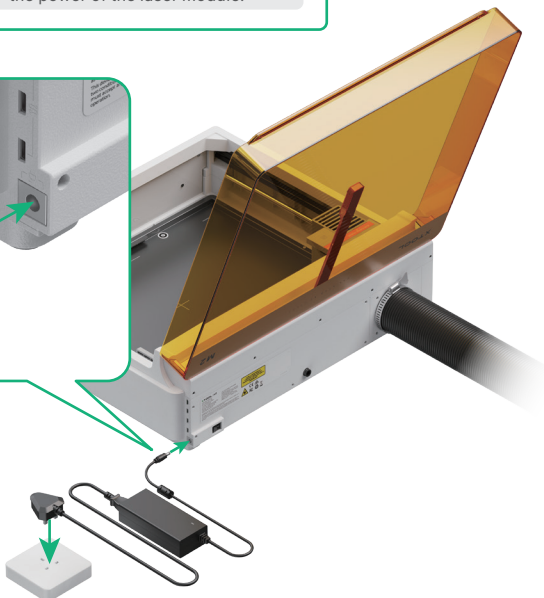
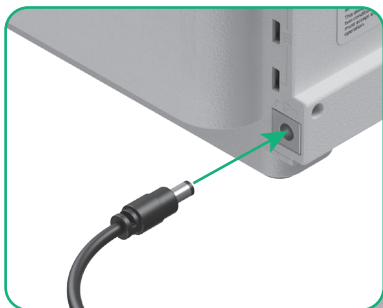

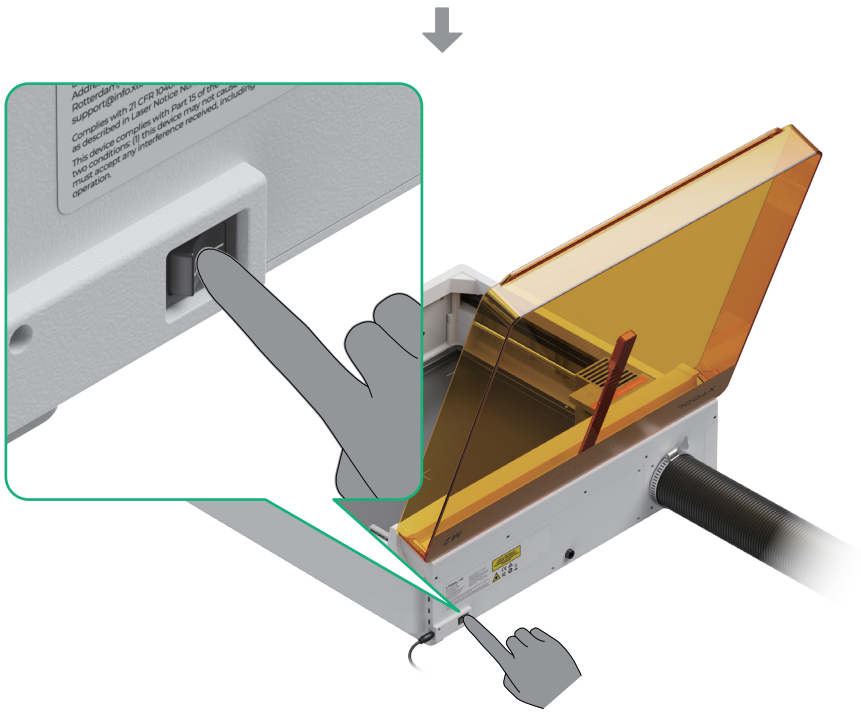

Use xTool M2 20W/40W Module

1 Get the xTool software



Go to s.xtool.com/software to get the xTool software

2 Connect xTool M2 to your computer

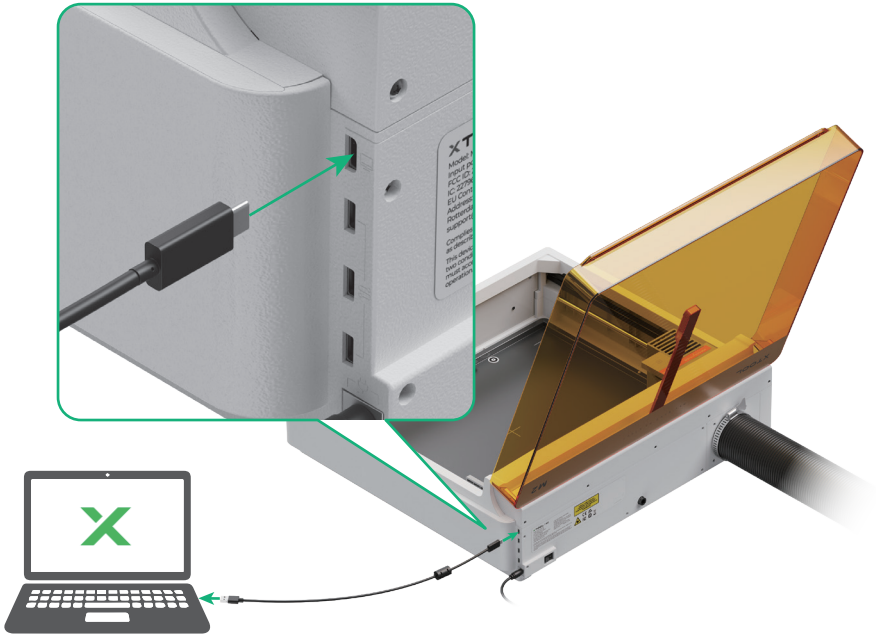
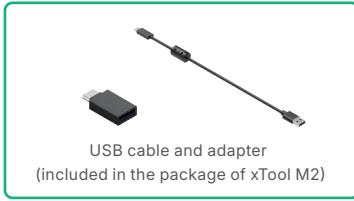

Compliance statements

EU Declaration of Conformity

Hereby, Makeblock Co., Ltd., declares that this product is in compliance with the essential requirements and other relevant provisions of Directive 2014/30/EU and the RoHS Directive 2011/65/EU & (EU) 2015/863. The full text of the EU declaration of conformity is available at the following internet address: support.xtool.com/article/2084

EU responsible person

EU responsible person: Makeblock Europe B.V.

Address: Westplein 12, 3016 BM, Rotterdam, the Netherlands

E-mail address: support@info.xtool.com

FCC statement

This device complies with Part 15 of the FCC Rules. Operation is subject to the following two conditions:

(1) This device may not cause harmful interference, and (2) this device must accept any interference received, including interference that may cause undesired operation.

Warning: Changes or modifications not expressly approved by the party responsible for compliance could void the user's authority to operate the equipment.

NOTE: This equipment has been tested and found to comply with the limits for a Class B digital device, pursuant to Part 15 of the FCC Rules. These limits are designed to provide reasonable protection against harmful interference in a residential installation.

This equipment generates uses and can radiate radio frequency energy and, if not installed and used in accordance with the instructions, may cause harmful interference to radio communications.

However, there is no guarantee that interference will not occur in a particular installation. If this equipment does cause harmful interference to radio or television reception, which can be determined by turning the equipment off and on, the user is encouraged to try to correct the interference by one or more of the following measures:

- Reorient or relocate the receiving antenna.
- Increase the separation between the equipment and receiver.
- Connect the equipment into an outlet on a circuit different from that to which the receiver is connected.
- Consult the dealer or an experienced radio/TV technician for help.

Responsibility party: XTL US INC.

Responsibility party address: 2019 LEGHORN STREET, MOUNTAIN VIEW, CA 94043

Website: support.xtool.com

IC Statement

This digital apparatus complies with CAN ICES (B) / NMB (B).

Déclaration d'Industrie Canada Cet appareil numérique est conforme à la norme CAN ICES (B) / NMB (B) du Canada.

Disposal & recycling information



This symbol indicates that this product shall not be treated as household waste. Instead, it shall be handed over to the applicable collection point for the recycling of electrical and electronic equipment.

After-sales services

For technical support, contact us at support@info.xtool.com.

For more information about after-sales services, visit support.xtool.com.

XTOOL